

FEATURES & SPECIFICATIONS

INTENDED USE — The Lithonia Lighting JEBL LED High bay is an affordable LED solution for users who prefer a luminaire with the look and feel of a round form factor. The JEBL delivers comfortable and uniform lighting from mounting heights up to 30ft

Certain airborne contaminants can diminish the integrity of acrylic and/or polycarbonate.
[Click here for Acrylic and Polycarbonate Environmental Compatibility table for suitable uses.](#)

CONSTRUCTION — JEBL features a white diecast aluminum housing along with a removable diecast aluminum driver housing. Optional clear polycarbonate or diffuse aluminum reflectors available separately.

OPTICS — A .16" thick clear tempered glass lens protects LEDs. Placement, spacing and aperture of LEDs provides a 120 degree spread of light.

ELECTRICAL — High-efficiency LEDs. 0-10V dimming standard for a dimming range of 100% to 10%. Input voltage is MVOLT(120-277V). Suitable for 50/60Hz. 6kV/3kA of surge protection is standard. L90 > 54,000 hours.

INSTALLATION — 1/4" NPT eye bolt with 1/2" thick loop and 17 3/4" cord with dimming lead provided for easy installation. Optional surface mount bracket allows flexibility by adjusting in 15 degree increments for a total range of 150 degrees.

LISTINGS — UL/C-UL listed to US and Canadian Safety Standards. Wet location listed. For use under covered ceilings. For use in ambient temperatures from -40°F (-40°C) to 131°F (55°C). IP65 rated.

DesignLights Consortium® (DLC) Premium qualified product. Not all versions of this product may be DLC Premium qualified. Please check the DLC Qualified Products List at www.designlights.org/QPL to confirm which versions are qualified.

WARRANTY — 5-year limited warranty. Complete warranty terms located at:
www.acuitybrands.com/CustomerResources/Terms_and_conditions.aspx

Note: Actual performance may differ as a result of end-user environment and application.

All values are design or typical values, measured under laboratory conditions at 25 °C.

Specifications subject to change without notice.

Catalog Number
Notes
Type

LED High Bay

JEBL



ORDERING INFORMATION

Lead times will vary depending on options selected. Consult with your sales representative.

Example: JEBL 18L 50K 80CRI WH

Series	Lumens	Color Temperature	Color Rendering Index	Finish
JEBL	12L 12,000 lumens 18L 18,000 lumens 24L 24,000 lumens 30L 30,000 lumens	40K 4000 K 50K 5000 K	80CRI 80 CRI	WH White Finish

Accessories: Order as separate catalog number.

JEBLPCLR1 M4	Polycarbonate clear reflector for 12L and 18L
JEBLDALR1 M4	Diffuse Aluminum reflector for 12L and 18L
JEBLPCLR2 M4	Polycarbonate clear reflector for 24L and 30L
JEBLDALR2 M4	Diffuse Aluminum reflector for 24L and 30L
JEBLSMB1 M6	Surface mount bracket for 12L and 18L
JEBLSMB2 M6	Surface mount bracket for 24L and 30L
JCBLSC120	Safety cable 120"
JCBLSC240	Safety cable 240"

LED High Bay

REFLECTORS



JEBLDALR

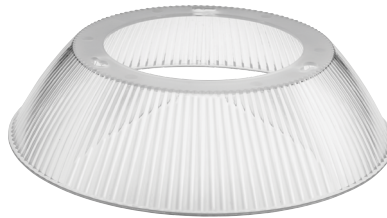

JEBLPCLR



JEBL with DALI

OPERATIONAL DATA

Lumen Package	Color Temperature	Color Rendering Index	Lumens	Wattage at 120 and 277	Lumens per Watt	Comparable Light Source:	Weight	Pallet Quantity
12L	40K	80CRI	13286	92.4	144	4-lamp T5HO, 6-lamp T8	9.7 lbs	45
	50K							
18L	40K	80CRI	19680	136	145	6-lamp T5HO, 8-lamp T8, 400W HID	9.7 lbs	45
	50K							
24L	40K	80CRI	26558	181.6	146	8-lamp T5HO, 400W HID	14.1 lbs	20
	50K							
30L	40K	80CRI	31423	218	144	10-lamp T5HO, 575W HID	14.1 lbs	20
	50K							

PHOTOMETRICS

See www.lithonia.com.

LED High Bay

DIMENSIONS

All dimensions are in inches unless otherwise indicated.

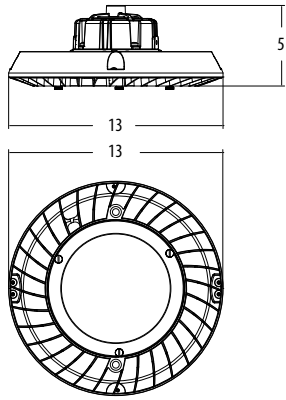

JEBL 12L/18L

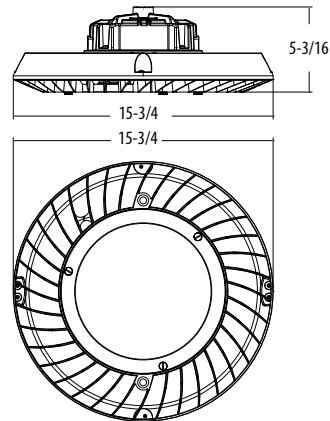
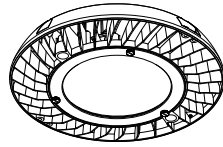

JEBL 24L/30L

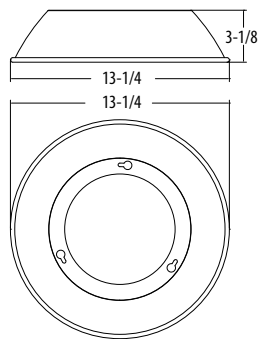
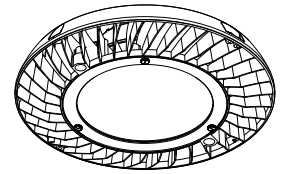

JEBLDARL1

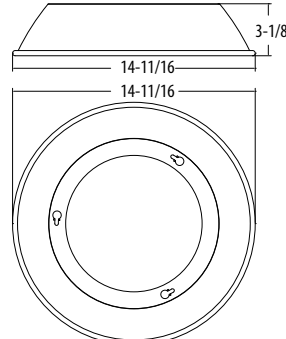
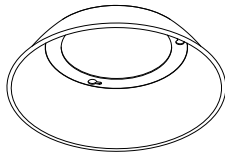

JEBLDARL2

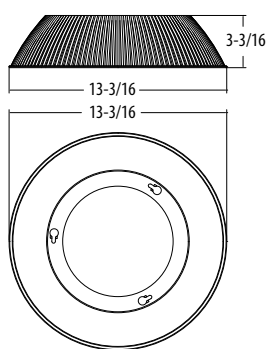
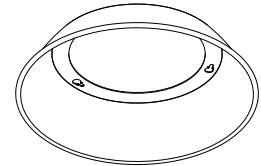

JEBLPCLR1

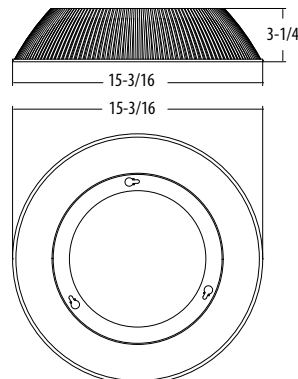
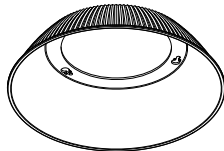

JEBLPCLR2

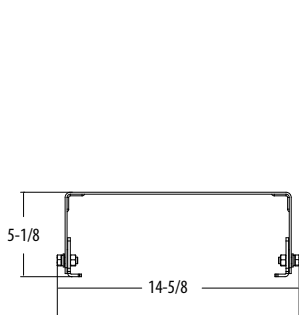
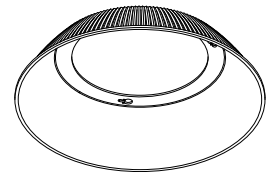

JEBLSMB1

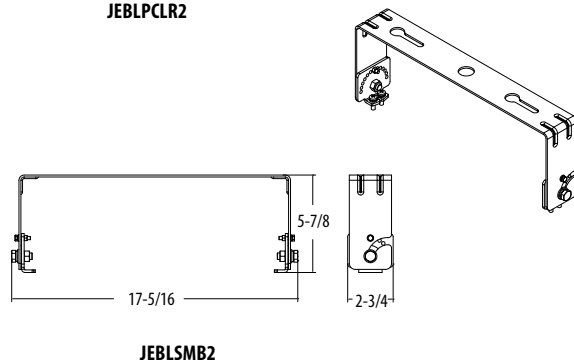
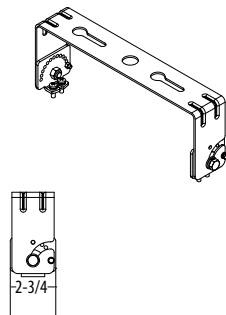

JEBLSMB2